

CHAPTER 15

High Pressure Burner Construction

The construction of this type burner whose basic principles and essential elements were presented in the preceding chapter is here given by showing the various details of a well known burner as actually made.

The sectional view fig. 1, gives a general idea of the external appearance of the burner as well as internal construction. Different parts and their functions are brought out graphically by the surrounding illustrations with arrows pointing to each part whose function is indicated.

Just below the fuel pump is the fuel regulating unit of the combined cut off and pressure relief type. Compare with fig. 4. Chapter 14.

Electrical Parts.—Attached and built into the burner are several parts of the electric system. They are:

1. Motor.
2. Transformer.
3. High tension leads.
4. Electrode assembly.

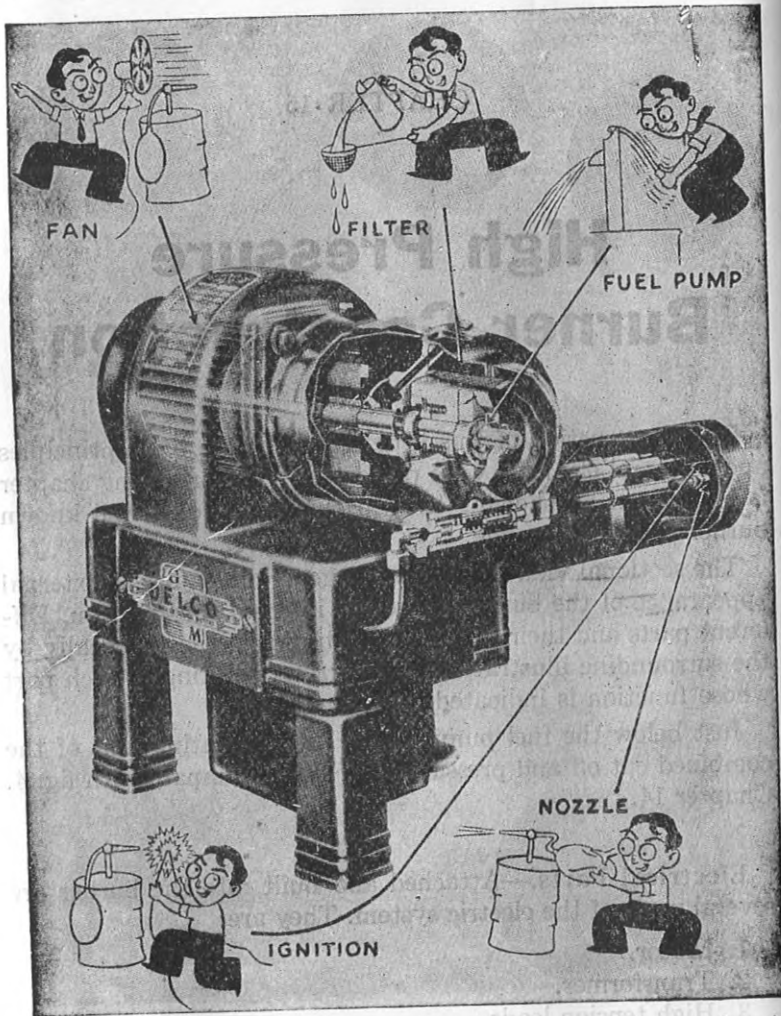

FIG 1—Sectional view of a high pressure domestic burner showing construction with graphics showing the function of each part. Note combined shut off and pressure relief valves just below the fuel pump.

The Motor.—The motor which runs the fan and pump operates from the regular 110 volt house current.

In the majority of cases where oil burners are in use, this current is 110 volt, 60 cycle alternating current. There are however, sections where special voltage, frequency or type of current is used—even in some cases direct current. For such, a motor must be provided suited to the current to be used.

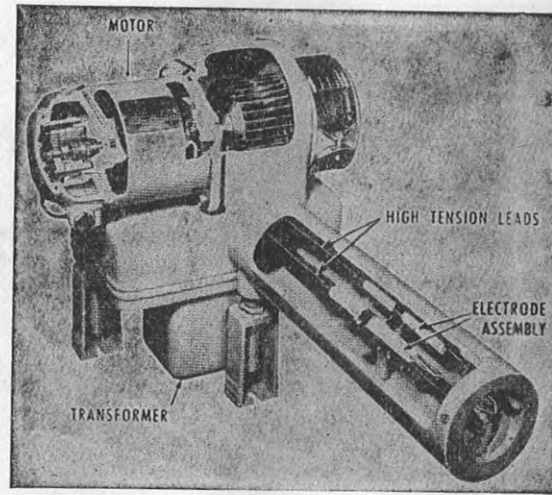

FIG. 2—Parts of the electrical system built into the burner.

Ques. What is the usual type of motor used?

Ans. For alternating current, the split phase starting induction motor.

Ques. How does it work?

Ans. It works on a single phase current. The rotor is of the squirrel cage type and the field has two sets of windings, a starting and a running winding. After the motor comes up to speed, the current on the starting winding is thrown off.

The fan and pump are both connected to the main shaft of the motor, accordingly the fan and pump start with the motor.

Fig. 3 shows the construction of a split phase motor.

Ignition Transformer.—There is no standard location for the transformer, for instance, it is mounted underneath the motor and blower housing on the burner shown in fig. 2 and

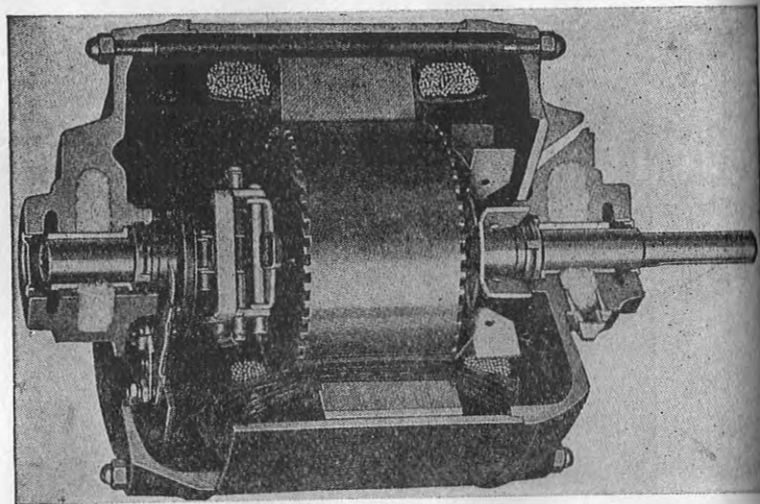

FIG. 3—Sectional view of split phase motor which runs the fan and fuel pumps

on top of the burner shown in fig. 4. It provides the high voltage necessary for ignition.

Ques. What voltage is provided by the transformer?

Ans. It varies from 5,000 to 15,000 volts to meet the requirements of the various types of burners.

Ques. What is provided on some transformers to prevent radio interference?

Ans. A copper barrier assembled between the primary and secondary windings and attached to the core.

Ques. How does it work?

Ans. The barrier positively grounded to the transformer core, collects the high frequency waves generated by the spark

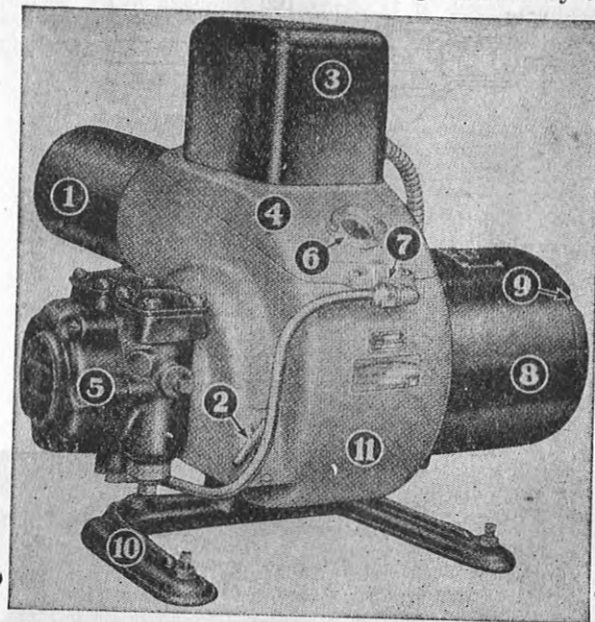

FIG. 4—Ignition transformer located on top of Johnson burner, *The parts are:* 1. Draught tube; 2. counter-balanced draught shutter; 3. transformer; 4. ignition and firing assembly plate; 5. pump strainer and valve unit; 6. pyrex fire inspection holes; 7. oil feed tube from pump to nozzle; 8. motor; 9. built in thermal motor protector; 10. legs; 11. fan housing.

up and dissipates them to ground which eliminates the possibility of interference being transmitted to the lighting circuit and thence to the radio receiver.

The Electrodes.—These consist of a steel wire encased in a white porcelain like insulating material. One end of each

electrode is connected by means of a flexible lead directly to the high side of the ignition transformer.

The other ends of the electrode points are made of a special heat resisting material and normally are separated about $\frac{1}{8}$ inch from each other and are placed about $\frac{1}{32}$ in. out of the oil spray as shown

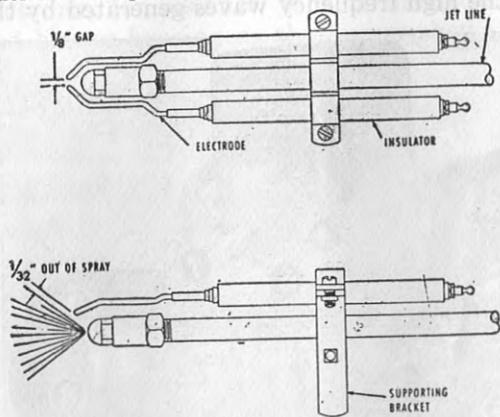

Figs. 5 and 6—Plan and elevation of electrode assembly.

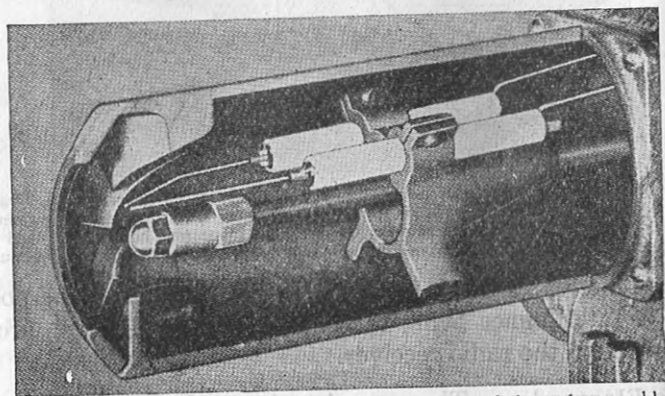

FIG. 7—Sectional view showing appearance and placement of electrode assembly as installed in burner draught tube. View also shows a turbulator located in advance of the burner nozzle.

in figs. 5 and 6. Their position as connected to the jet line in the draught tube is shown in fig. 7.

Fuel Pump.—Usually a gear pump of the gear and crescent type shown in fig. 8, is provided.

The sectional view, fig. 9 shows a pump unit of this type with regulating valve assembly attached. It is direct connected to the motor through a flexible coupling.

The pump has no stuffing boxes.

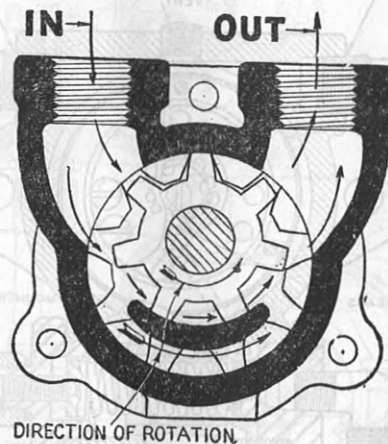

FIG. 8—Sectional view of gear and crescent type of fuel gear pump with arrows showing direction of rotation and flow.

Seal rings, held in place by a spring effect an efficient seal which causes less friction than that caused by a stuffing box.

Fig. 10 shows in detail the flexible coupling and seal ring as well as other details.

Ques. How does the pump work?

Ans. The shaft, driven by the electric motor, turns a small inner gear which in turn operates the larger gear. The stationary crescent set in between the two gears establishes the division between the inlet and discharge sides.

Combined Cut Off and Pressure Relief Valves.—The sectional view, fig. 11, shows actual construction of a unit of this type together with the compact assembly of pump and strainer. The different parts are named, with arrows clearly showing construction. Compare this construction view with the elementary diagram fig. 4. Chapter 14.

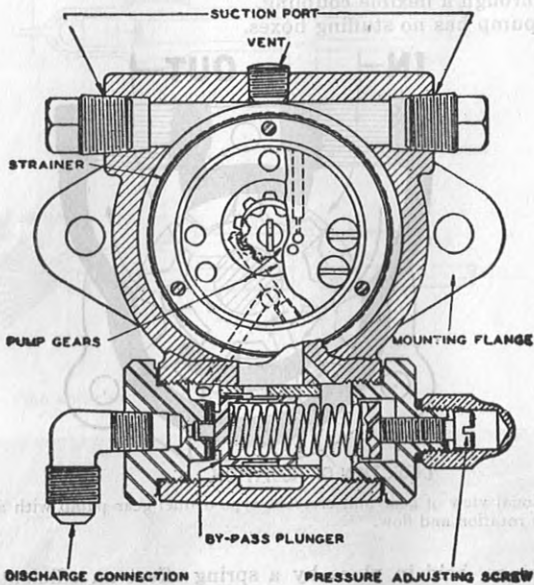

FIG. 9—Sectional view of gear type fuel pump and valve control assembly.

The Air System.—The conventional make up of the air system comprises a fan, air shutter, draught tube and turbulator at or near the end of the draught tube, for instance as shown in fig. 12.

Ques. What is the construction of the fan?

Ans. It consists of a "squirrel cage" series of vanes or blades mounted on the rim of a wheel. These vanes are slanted forward in such a manner as to provide the maximum discharge of air.

Ques. How is the fan mounted?

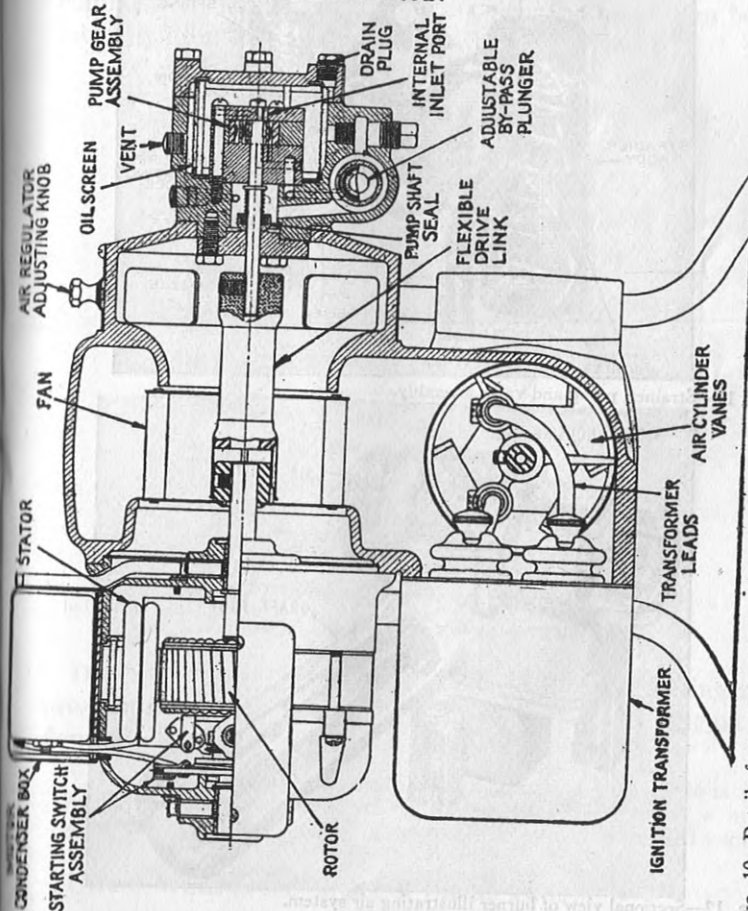

FIG. 10—Detail of motor, pump and flexible coupling and other details.

Ans. Direct connected to motor through a flexible shaft.

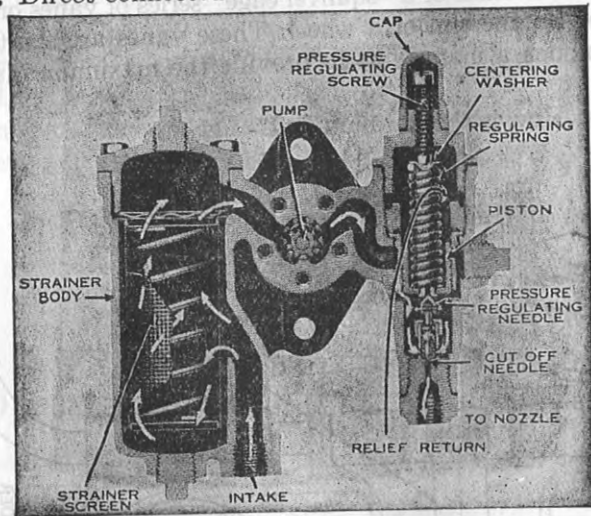

FIG. 11—Strainer, pump and valve assembly.

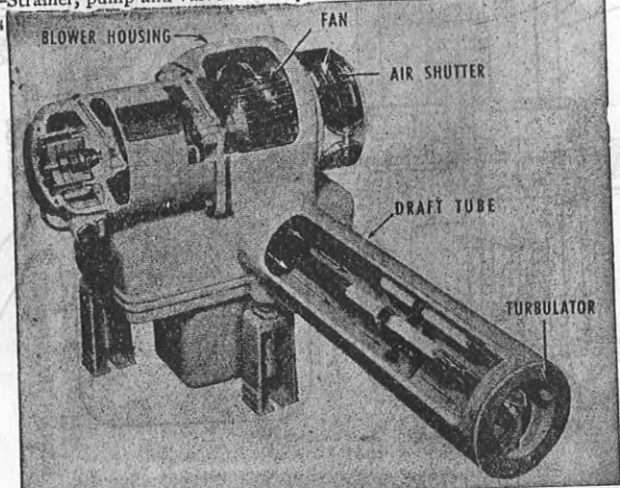

FIG. 12—Sectional view of burner illustrating air system.

Fig. 13 shows plainly construction of the fan and flexible coupling.

Ques. Describe the operation of the air system.

Ans. The fan draws air into the fan housing and forces this air through the draught tube and turbulator and into the combustion chamber. The amount of incoming air can be regulated by adjusting the air shutter.

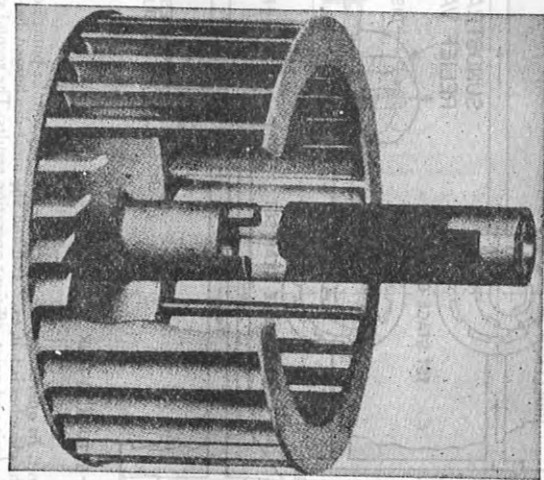

FIG. 13—Fan and flexible coupling. In this design the coupling engages jaws of the fan hub as shown.

Draught Tube Assembly.—This part of the casing measures approximately $4\frac{1}{2}$ ins. in diameter and 20 ins. long on most domestic size conversion burners.

The oil jet line leading from the oil pump to the nozzle is placed at the center of the tube and the electrodes are held in a bracket clamped to the jet line. This assembly is shown in figs. 15 and 16.

Ques. What is the object of the air cone?

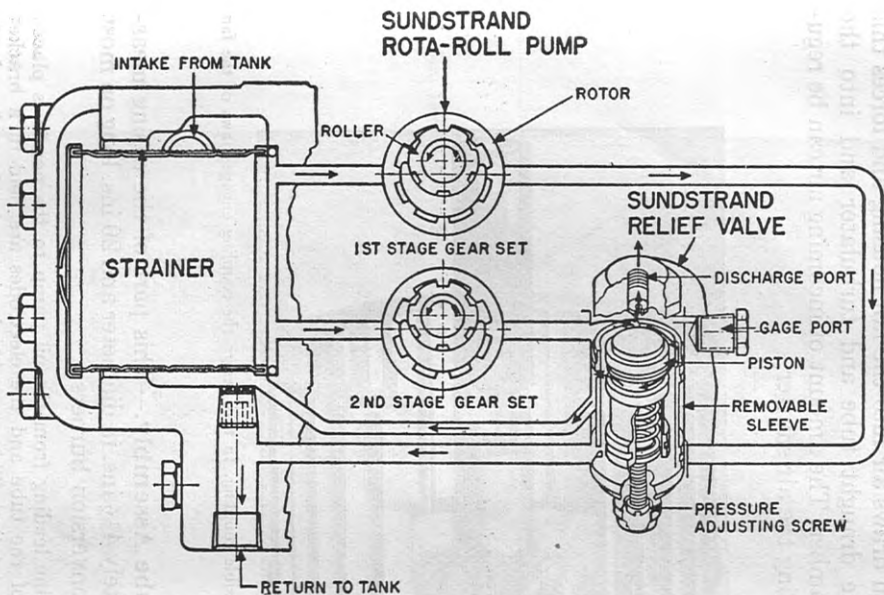

Fig. 14.—Sundstrand two stage fuel unit. *In operation*, the first stage gear set (intake pump) draws oil from the inlet at the top of the strainer chamber. When the chamber is full, excess oil and any air is discharged directly into the tank return line. In this manner, air is purged from the unit and quiet, efficient operation results. The second stage gear set (pressure pump) pumps only solid air free oil from the bottom of the strainer chamber reservoir. From this point, the oil flows to the pressure chamber of the balanced valve and from there, the flow of oil is the same as for the J unit. The two stage unit must be mounted with the valve down to purge air as previously described. The by-pass plug is not assembled in the H units at the factory, but is shipped in a cloth bag, attached to the unit. The by-pass plug must be inserted in the pump when used as a two-pipe system. A 3/16 in. Allen wrench is used to insert or remove the by-pass plug.

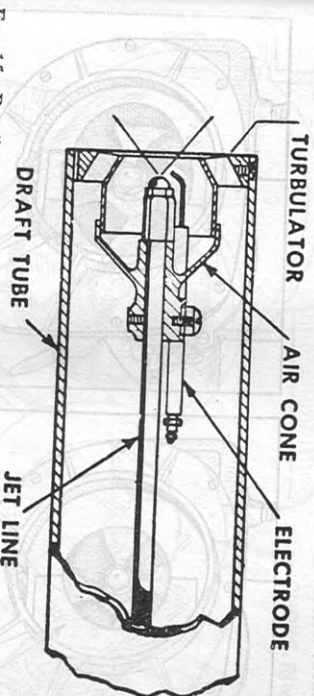

Fig. 15—Detail of draught tube showing turbulator air cone, etc.

Ans. It is to improve performance on smaller size flames, being used in conjunction with a turbulator.

Turbulator.—At the end of the draught tube is a set of vanes slightly spiralled in form; this is the turbulator.

Ques. What duty is performed by the turbulator? (See fig. 15).

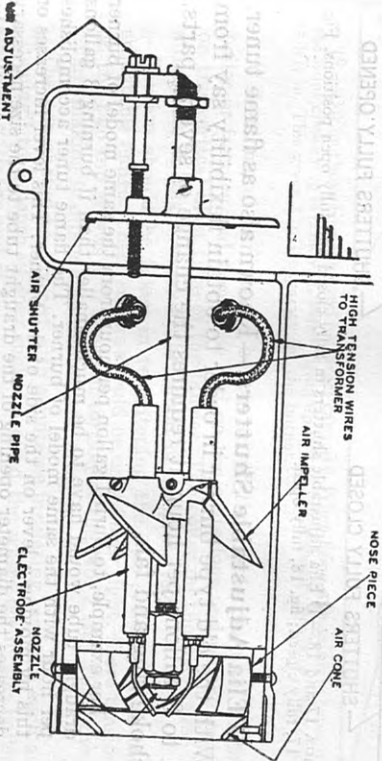
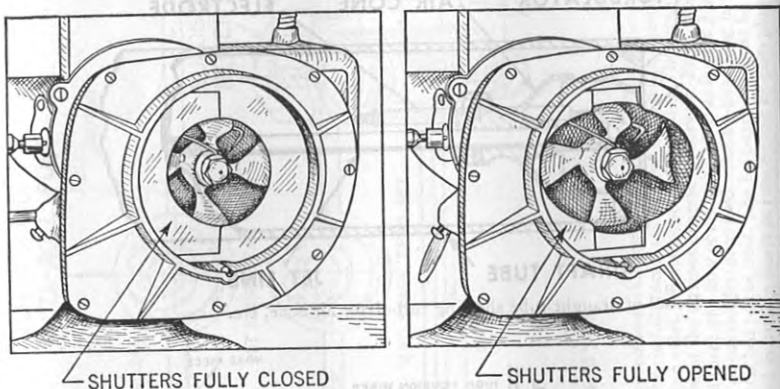

Fig. 16—Detail of draught tube showing double turbulator consisting of air impeller and nose piece.

Ans. As the air is forced through these vanes, it is given a swirling motion just before it strikes the oil spray. This motion provides a more thorough mixture of the oil and air resulting in better combustion.

The shape of the turbulator varies in different models, but the purpose is the same—to thoroughly mix the air and oil spray. Fig. 16 shows a double turbulator called by manufacturers, air impeller and nose piece. The illustration shows also other parts.



FIGS. 17 and 18.—D'Elia adjustable shutters in fully closed and fully open positions. Fig. 17, fully closed; fig. 18, fully open.

D'Elia Adjustable Shutters.—Known also as flame tuner. With the old type burner in order to obtain flexibility say from 1 to 3 gallons per hour, it requires the change of several parts, choke ring and fan.

For example, to burn 1 gallon per hour from the same model of burner draught tube would have to be much smaller than if burning 3 gallons per hour with the same model of burner. The flame tuner accomplishes this by moving a lever on the side of the burner. This lever increases or decreases the diameter opening of the draught tube to the size necessary to give a closer adjustment. The adjustment range is greater than by using different size choke rings.

Sun Ray Vertical Tube or Firing Head of VS Burner.—The installation is shown in fig. 19. The firing head should be centered in the boiler or furnace carefully. The top of the firing head (secondary air nozzle 1) should be two to four inches above the water leg of a boiler or the same distance above the grate lugs on a furnace.

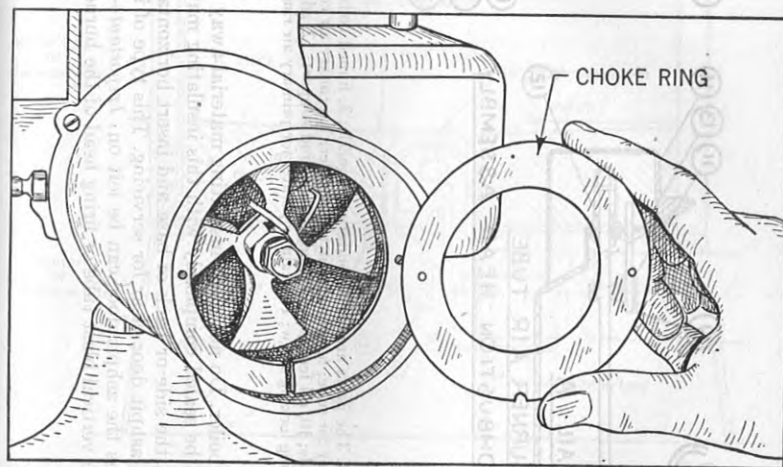
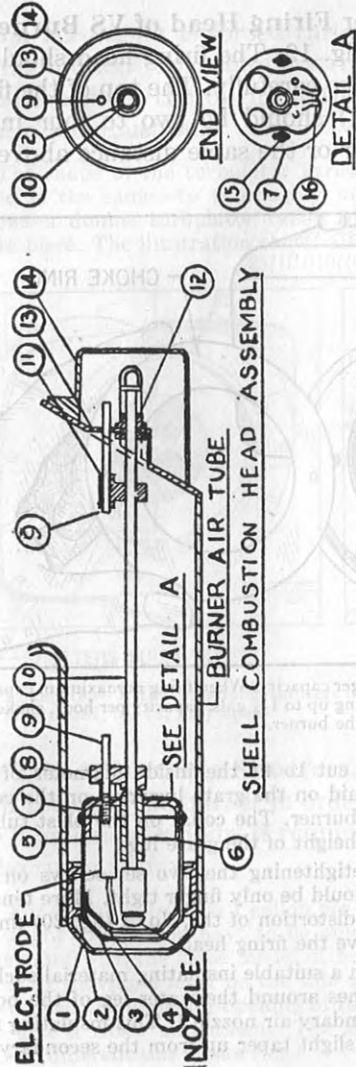

FIG. 19.—D'Elia choke ring removed for larger capacity. When firing at maximum capacity, the front choke ring is removed. When firing up to $1\frac{3}{4}$ gals. capacity per hour, choke ring is left in. This gives 2 in 1 capacity for the burner.

A sheet metal pan should be cut to fit the inside diameter of the boiler or furnace and should be laid on the grate lugs and on the collar on the vertical blast tube of the burner. The collar on the blast tube is adjustable in height to equal the height of the grate lugs.

Caution should be taken in retightening the two set screws on the adjustable flange. These screws should be only finger tight. More tension on the two top screws will cause distortion of the No. 2 (fig. 20) finned collar, making it difficult to remove the firing head.

The pan should be covered with a suitable insulating material such as "Insulag" to a depth of four inches around the water leg of the boiler and flush with the end of the secondary air nozzle 1. This insulating material can be either flat or have a slight taper up from the secondary air



Figs. 20 to 22.—Sun Ray vertical firing head. The parts are: 1, Secondary air nozzle; 2, finned collar; 3, outer primary air nozzle; 4, inner primary air tube; 5, primary air tube holder; 7, primary air control ring; 8, electrode holder; 9, primary air assem.; adjustment rods; 10, oil feed pipe; 11, adjustment rod support; 12, adjustment knob; 13, rear cover plate; 14, rear cover; 15, primary air ring locking screw; 16, scale or pointer for primary air ring setting.

nozzle toward the perimeter of the boiler. Do not pitch insulating material away from the secondary air nozzle. All secondary air should be sealed completely with this insulating material.

Whenever possible, cut a hole in the side or back of base and insert horizontal tube through this opening thereby keeping the whole ashpit door clear for servicing. This type of installation also improves the appearance of the job as the ashpit door can be left on. *Important*—Be certain that no insulating material is left inside the vertical blast tube or firing head of the burner.

Shell Combustion Head.—The way in which the burner head performs its functions determines how much of the fuel's potential heating value becomes available as usable heat. Of prime importance is the intimate mixing of every particle of oil with enough air to burn it completely.

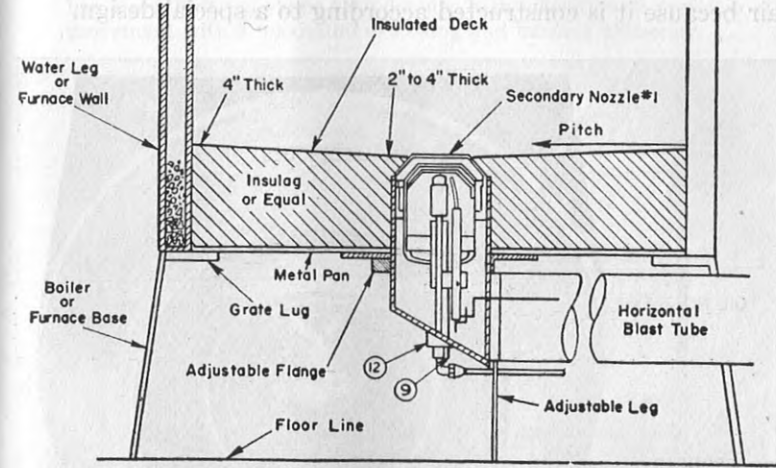

FIG. 23.—Sun Ray vertical tube or firing head of VS burner.

If too little air has been supplied, or if enough has been supplied but cannot reach each particle of oil while it is burning, the particle will not burn completely, but will form soot and carbon. This means loss of heat.

Soot and smoke formation can be reduced if more air be supplied for the burning operation, but even this is not a perfect solution. Although the oil may burn completely, if it be given additional quantities of air, heating efficiency will still be low. The heat produced is now wasted in heating excess air which escapes up the chimney. Excess air is not a satisfactory substitute for efficient mixing of air and oil.

It can be said then that efficient combustion requires smokeless burning with a minimum of excess air.

The high pressure gun type oil burner employs a spraying nozzle with an extremely small orifice (.008 ins. in diameter and upward) from which tiny droplets or particles of oil are sprayed out under high pressure. The oil nozzle, a precision built device, may be likened to the spray nozzle on a garden hose.

The Shell combustion head does not employ high velocity air because it is constructed according to a special design.

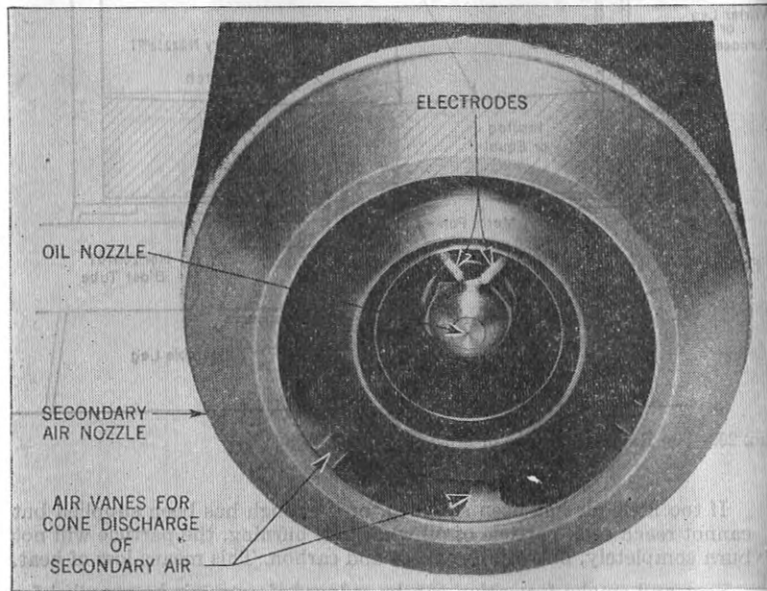

Fig. 24.—Shell combustion head showing construction.

Ques. How does the air move out in the Shell combustion head?

Ans. The air flares out at a wide angle to form the surface of a cone which conforms to the shape of the oil spray cone.

Ques. What is the result?

Ans. It is claimed that this provides an optimum of mixing with a maximum of burning area.

There is ample air in intimate contact with each tiny droplet of oil, and the air is available through the period of burning. The flame mass has a regularity of shape that denotes high velocity and precision of air movement with a maximum of mixing and burning efficiency.

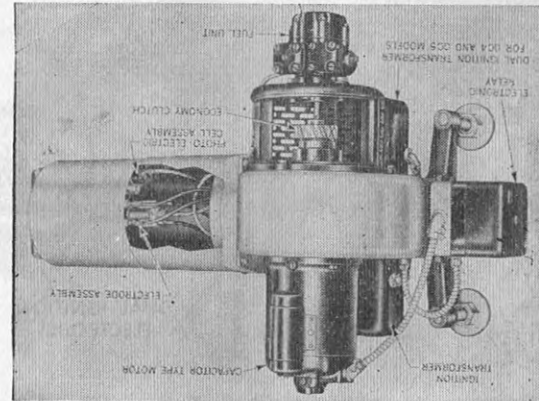

Fig. 25.—Gilbarco Models GC3, GC4, GC5 oil burners with dual ignition and electronic controls. Note the electrode assembly showing two pair of electrodes, dual ignition transformer, photo-electric cell assembly, etc. Continuous ignition.

It is claimed that only 5 to 10% of excess air is used with the Shell combustion head.

Ques. Why is 5 to 10% excess air necessary?

Ans. To prevent the formation of carbon monoxide and to keep the fire going under variable atmospheric conditions.

Ques. How about adjustments?

Ans. The Shell combustion head can be adjusted by means of mechanisms operated from the back of the burner assembly.

128F High Pressure Burner Construction

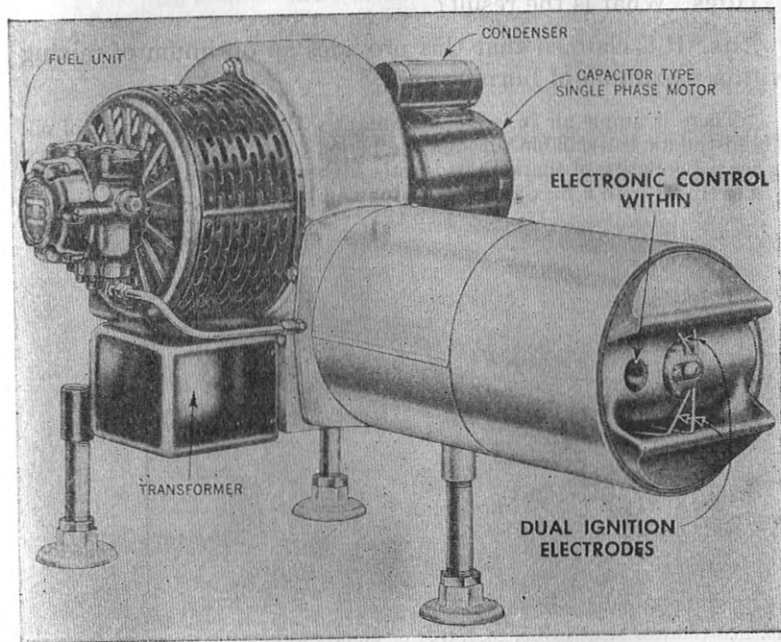

FIG. 26.—Gilbarco burner view from head showing the two pair of electrodes, also opening at side for electronic tube. The combustion control is a burner-mounted electronic relay for use with operating controls, such as thermostat, aquastat, etc. of the low voltage type. The limit control is of the line voltage type.